

LASERLYTE Alignment System

Features

Plug and play system

Available in red or green outputs

Wide range of projections including

- Dot
- Line
- Cross
- Line + dot

Variable intensity Dot and Cross models

User adjustable focus control

110/240 Vac & 12/24 Vdc powered

Wide range of mounting options and accessories

No technical laser experience required



The Laserlyte alignment system is a unique, user adjustable, plug and play laser system suitable for a wide range of applications including alignment and positioning of materials including garments, cloth, paper, wood and metal.

Applications

Garment manufacturing

Screen printing

Tyre manufacturing

Saw cutting

Fabric cutting

Patient positioning

Rotary press alignment

Glass cutting and drill positioning

Graphics alignment

The system has a wide range of projections including variable intensity dot, adjustable line and variable intersecting angle cross. A wide range of wavelengths and intensities are available in order to maximise the visual appearance of the projection even against the darkest materials. This user friendly design allows simple adjustable focus over a wide range of distances. Complete with mounting brackets, electrical leads and power supply the system is ready to use with no previous laser experience required.



THE LASERLYTE ALIGNMENT SYSTEMS FEATURES

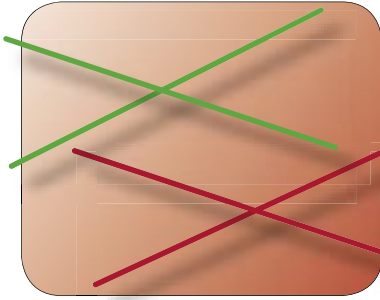

MULTIPLE PROJECTIONS AND BRIGHTNESS

The LaserLyte alignment system has various power and wavelength outputs from the GreenLyte range (532 nm, 5 mW) to the V red range (635 nm, 15 mW). Each one of the ranges has different projections from dots to variable intersecting crosses. For a guide on brightness and projections refer to the chart on page 3.

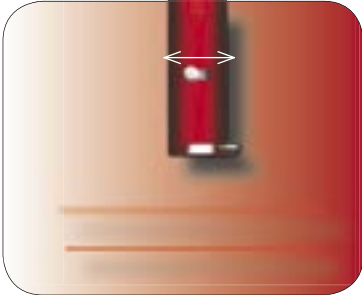

ADJUSTABLE FOCUS CONTROL

The LaserLyte system has an adjustable focus control which allows the user to focus the laser at any required distance. A focus key is supplied to enable this.



PLUG AND PLAY SYSTEM

The LaserLyte system has been designed so that the user can operate the system efficiently and effectively via simple DC connector jack plugs.



UNIVERSAL POWER SUPPLY

The LaserLyte system has been designed to work with its own universal power supply which runs on 110 - 240 Vac. The power supply is available as either a 1 outlet unit to power one laser (PS-1) or as a 4 outlet version which can power up to four lasers (PS-4). Please note the Greenlyte range can only be operated from the PS-1 power supply. A 12/24 Vdc power adaptor is also available that allows the Laserlyte to be run directly from a machine power source.



ADJUSTABLE PROJECTIONS



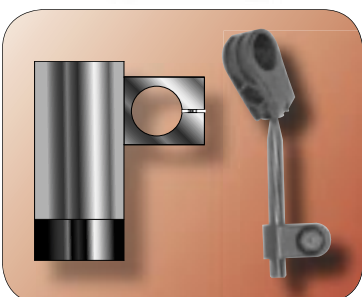

















The wide range of Laserlyte modules feature an adjustable projection control, this allows the user to vary the intensity of the dot, vary the length of the line and adjust the intersection angle of the cross to produce a 90° cross at any mounted position. (See matrix on page 3 for further details.)





MOUNTING



The LaserLyte system has two types of mounts, the MK1 mount for the V red range of lasers which rotates on a ball headed rod of 64 mm in length and an optional heavy duty mounting clamp which allows the lasers to be securely fixed at any required direction or angle. *(MK1 is included with the V red range but the heavy duty version may be purchased as an optional extra. In the case of the GreenLyte range the heavy duty clamp is standard)*

MODEL MATRIX AND PROJECTION OPTIONS

						
	Dot (D)	Dot With Variable Intensity (DVI)	Variable Length Line (VLL) Fan Angle: 30 to 80°	Long Line With Dot (VLL+D) Fan Angle: 30 to 80°	Intersecting (variable angle) Crossed Lines (RXL) Fan Angle: 55°	Small Cross with Variable Intensity (Xvi) Fan Angle: 9°
Standard Power Red V5 Range 650nm 5mW						
Bright Power Red V3 Range 635nm 5mW						
Super Bright Red V2 Range 635nm 10mW						
Ultra Bright Red V1 Range 635nm 15mW						

	Dot	Fixed Long Line Fan Angle: 55°	Intersecting (variable angle) Crossed Lines Fan Angle: 55°
Greenlyte Range 532nm 5mW			

KEY:

-  These units project a red output
-  These units project a green output

LINE LENGTH TABLE

If you require a variable line please look at the table below to work out which laser you require to give you the correct line at a specified distance. If you require a line projection from further distance than specified below you will need to use the Greenlyte range which produces a high visibility green line. (The Greenlyte range of lines are not variable in length)

		Line length required (meters)															
		0.0	0.5	1.0	1.5	2.0	2.5	3.0	3.5	4.0	4.5	5.0	5.5	6.0	6.5	7.0	7.5
Distance from object (meters)	0.5	V5VLL	V5VLL														
	1.0	V5VLL	V5VLL	V5VLL													
	1.5	V5VLL	V5VLL	V3VLL	V3VLL	V3VLL	V3VLL	V3VLL									
	2.0	V3VLL	V3VLL	V3VLL	V3VLL	V3VLL	V3VLL	V3VLL	V3VLL								
	2.5	V3VLL	V3VLL	V3VLL	V3VLL	V3VLL	V3VLL	V3VLL	V3VLL	V3VLL	V2VLL	V2VLL					
	3.0	V3VLL	V3VLL	V3VLL	V3VLL	V3VLL	V3VLL	V3VLL	V3VLL	V2VLL	V2VLL	V2VLL	V2VLL	V1VLL			
	3.5	V3VLL	V3VLL	V3VLL	V3VLL	V2VLL	V2VLL	V2VLL	V2VLL	V2VLL	V2VLL	V2VLL	V2VLL	V1VLL	V1VLL	V1VLL	
	4.0	V2VLL	V2VLL	V2VLL	V2VLL	V2VLL	V2VLL	V2VLL	V2VLL	V2VLL	V2VLL	V2VLL	V1VLL	V1VLL	V1VLL		
	4.5	V2VLL	V2VLL	V2VLL	V2VLL	V2VLL	V2VLL	V1VLL	V1VLL	V1VLL	V1VLL	V1VLL	V1VLL	V1VLL			
	5.0	V1VLL	V1VLL	V1VLL	V1VLL	V1VLL	V1VLL	V1VLL	V1VLL	V1VLL	V1VLL						
	5.5	V1VLL	V1VLL	V1VLL	V1VLL	V1VLL	V1VLL										
	6.0																

LASERLYTE APPLICATIONS

The Laserlyte alignment system has many applications some of which are below. If you would like to know further information about any other applications please either contact your local distributor or contact Global Laser.



EDGE ALIGNMENT

For edging alignment and positioning of material on floatation tables



GARMENT POSITIONING

For positioning of garments for pressing or heat sealing of motifs or embroidery



MACHINE ALIGNMENT

On snap, or rivet machines



CUTTING GUIDANCE

Saw blade or guillotine guidance

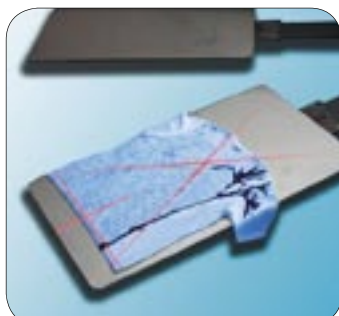

SCREEN PRINTING

On RF heat sealing & screen printing equipment

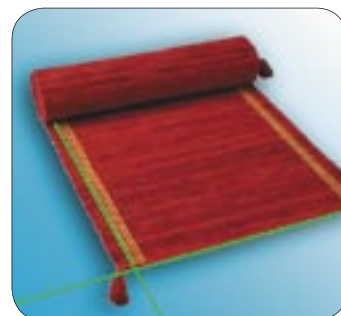

PATTERN ALIGNMENT

For pattern matching, material inspection and fabric spreading

LASERLYTE ACCESSORIES



When ordering the LaserLyte system the following accessories are included:

V Red range: 1 off Laser, 1 off MK-1 mounting clamp, 1 off 1.5 metre electrical lead and 1 off focus key. Please note the V red range you will need to purchase a PS-1 (1 way), PS-4 (4 way) or (1 way) 12 / 24Vdc power supply separately.



Greenlyte range: 1 off Laser (which produces all projections listed on page 3), 1 off heavy duty clamp, 1 off focus key, 1 off 3 metre electrical lead, 1 off PS-1 power supply and plug.

In addition to the above, the following LaserLyte accessories can be purchased to complement the range.

Mounting Accessories

Heavy duty mounting clamp	Heavy duty mounting clamp allows the Laserlyte alignment system to be securely fixed at any required direction or angle. The base plate has a series of threaded holes which allows the clamp to be fixed directly onto a machine or workbench. (Two versions are available one for the V range and one for the Greenlyte Range)	
Magnetic mount	The magnetic mount allows the heavy duty mounting clamp to be magnetically attached to a ferrous surface.	
Brackets	Brackets are available with holes at regular intervals. B12 - 30cm/12" B6 - 15cm/6" B4 - 10cm/4" B2 - right angled 10cm/4" BS - one of each	

Electrical Options

Power Supplies	PS-1 for 1 laser (110/240 Vac) PS-4 for up to 4 lasers (110/240 Vac) 12/24 Vdc for 1 laser (12/24 Vdc) The PS-1 & PS-4 power supplies comply with the legal requirements of LED on/off indicator. Both are fully Radio and High Frequency protected as is the rest of the system.	
Power Leads	Power leads are available in the following lengths: 1.5m, 3m, 5m, 10m	

TECHNICAL INFORMATION

MECHANICAL SPECIFICATIONS

	V Range	Greenlyte Range
Dimensions	14 mm dia x 69 mm	17 mm dia x 112 mm (with line & cross optics length is 128 mm)
Housing	Red anodized aluminium	Green anodized aluminium
Isolated body	Yes	Yes

OPTICAL SPECIFICATIONS

Beam power	1 mW to 15 mW *	5 mW
Wavelength	635 - 650 nm *	532 nm
Intensity distribution	Gaussian	Gaussian
Focus range	6 mm to infinity	500 mm to infinity (150 mm without line or cross optics)
Warm up time to 75% of full power	< 1 second	< 30 seconds
Delivery Set Focus	300 mm (user adjustable)	300 mm (user adjustable)

ENVIRONMENTAL SPECIFICATIONS

Operating case temperature	5°C to +40°C	5°C to +35°C
Storage temp	-10°C to +85°C	-10°C to +85°C
Operating humidity (%RH)	90	90
MTTF at 25°C	25,000 hours	5,000 hours

ELECTRICAL SPECIFICATIONS

Connector type	DC Power jack	DC Power Jack
Reverse - polarity protection	Yes	Yes

* = *Varies with model*

Specifications are typical at 25°C unless otherwise stated

LASER SAFETY

Our lasers are compliant to IEC 60825-1 standards. The lasers fall within one of the following classifications depending on power, wavelength and fan angle. The labels supplied with the units are shown below.

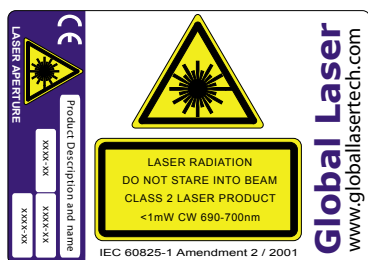

Class 2 Laser Label

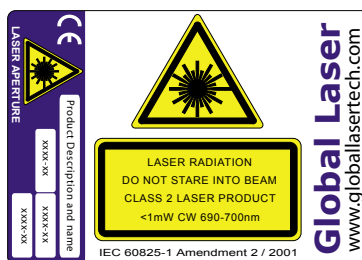

Class 2M Laser Label

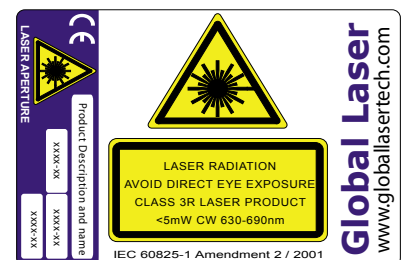

Class 3R Laser Label

QUALITY & WARRANTY

The LaserLyte is supplied with a 12 month parts and labour warranty. Our manufacturing operations are certified to ISO9001.



DIMENSIONS

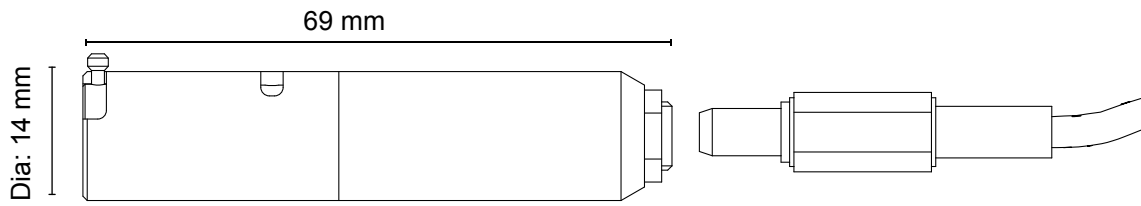

V - Red LaserLyte range

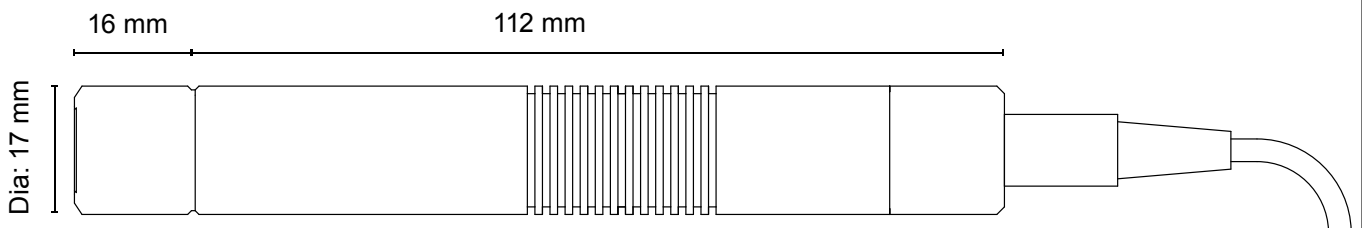

Greenlyte range

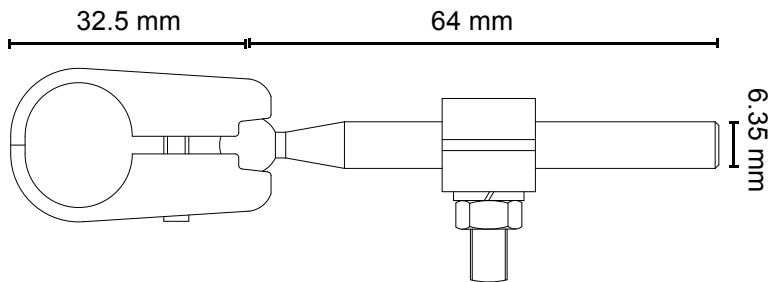
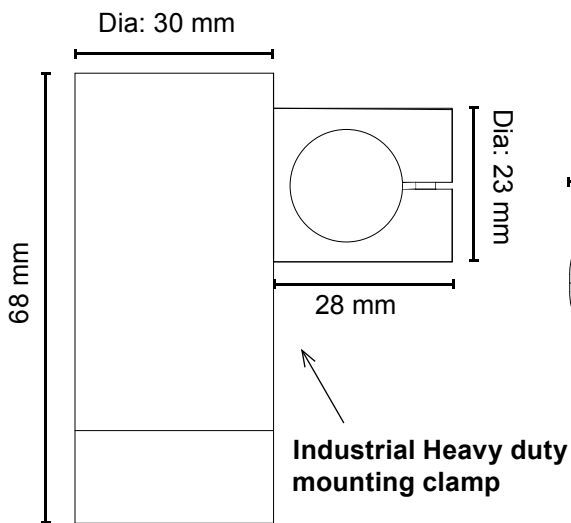

MK1 - Mounting kit (V Range only)

Please note: Global Laser reserve the right to change descriptions and specifications without notice

SUMMARY OF FEATURES & BENEFITS

- Variable line length - The only product which allows you to vary the line length simply to match the material you are working with, this results in achieving the maximum intensity from the laser for each application.
- 90° cross at every mounted position - Our product is the only product which allows you to achieve a 90° cross at every mounted position.
- Variable intensity dot - This allows you to reduce or increase the intensity of the dot to suit your visual needs when using different types of coloured material.
- Variable intensity small cross - This allows you to reduce or increase the intensity of the cross when using the laser at difference distances.
- Long line + centre dot - Allows for two way alignment and positioning of any material with just one laser.
- Transformers - 110 / 240 Vac mains power transformer or 12 / 24 Vdc machine power transformer.
- Small size - Very compact 14 mm diameter laser which takes up minimal space and is easily clamped with a range of mounting accessories.
- User adjustable focus - You can focus the laser to any desired distance while using it in your application without the need of removing lenses.
- Plug and play system - The LaserLyte system has been designed so that the user can operate the system efficiently and effectively via simple DC connector jack plugs.



Global Laser Ltd
Cwmtillery Industrial Estate
Abertillery. Gwent. UK. NP13 1LZ

T: +44 (0)1495 212213
F: +44 (0)1495 214004
E: sales@globallasertech.com
www.globallasertech.com

For further information about the Laserlyte you can contact your local distributor or you can contact Global Laser in the UK.

Your Local Distributor Is: